

# DYMENSO

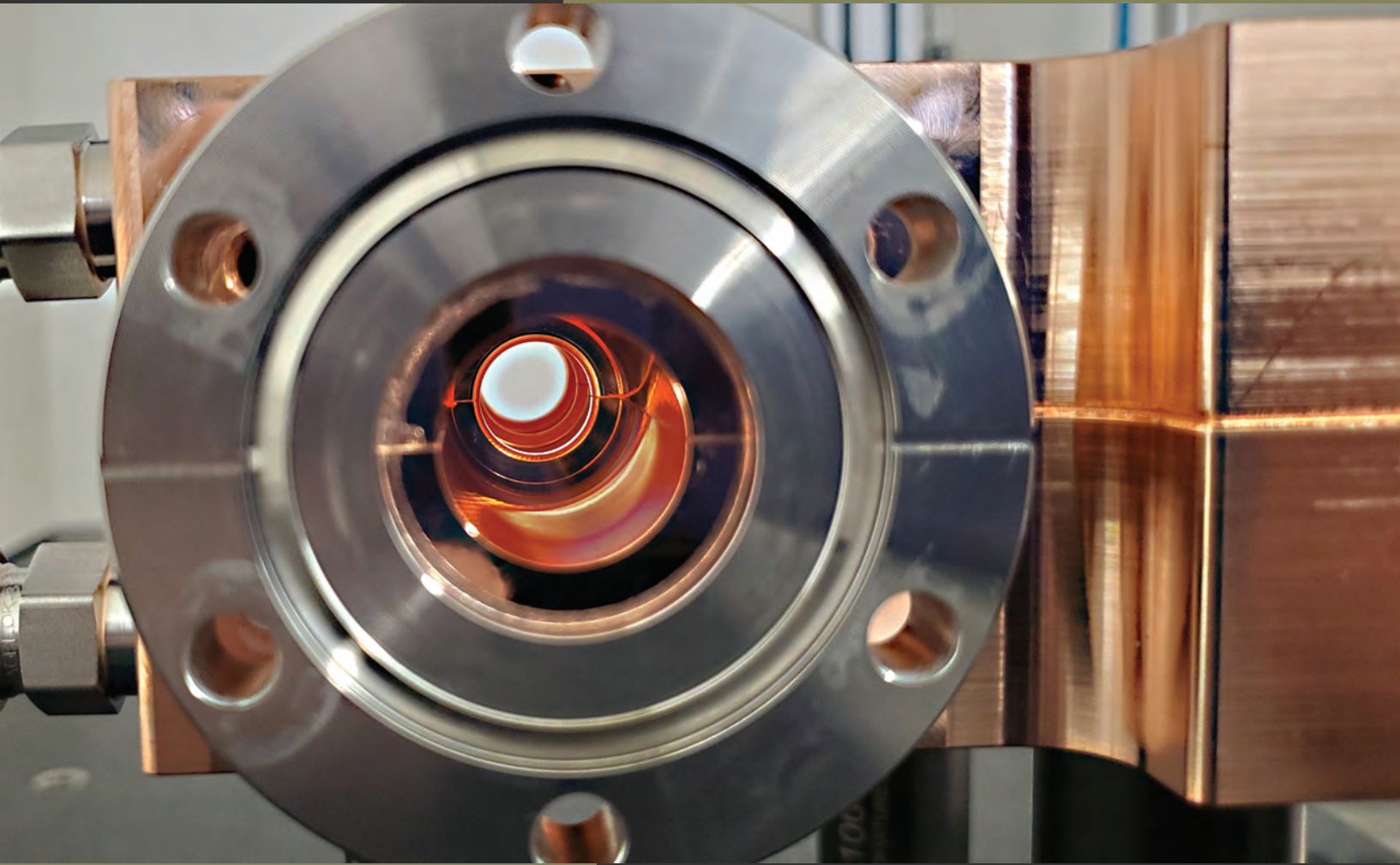

Analysis Driven Design Solutions

[www.dymenso.com](http://www.dymenso.com)

---

# 2008

Founded

**DYMENSO**

# 2009

**Engineering services** - Dymenso establishes a reputation for mechanical, thermal, electrostatic, and structural analysis in the microwave industry using Non-linear Finite Element Analysis and Computer Aided Design

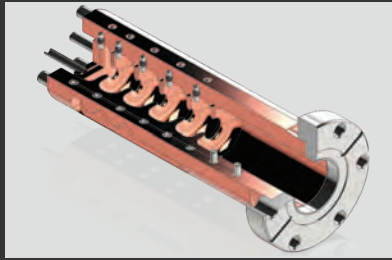
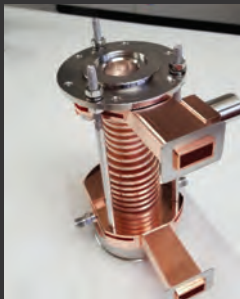
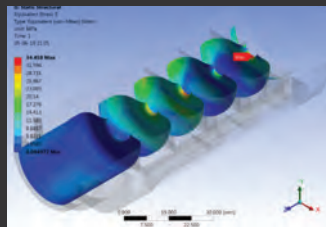
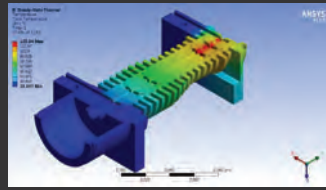

# 2011

**11.4 GHz Accelerator Structure** - Fabricated next generation 11.4 GHz accelerator structure for SLAC National Linear Accelerator Laboratory using elastic averaging as a precision alignment method



# 2012

**Microwave Continuous Wave (MW CW) Dummy Load** - Designed and fabricated a continuous duty 2 Megawatt dummy Load prototype for the US ITER fusion research program at Oak Ridge National Laboratory

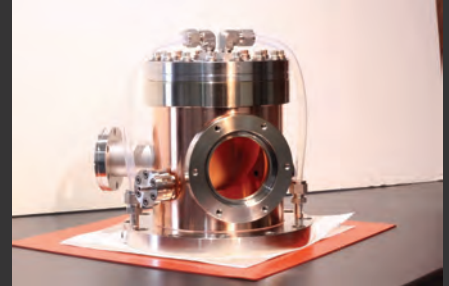

**Radar Components** - Delivered radar components to Lincoln Laboratory/MIT for Kwajalein millimeter-wave (MMW) radar

# 2014

**Precision Electron Gun (PGUN)** - Developed innovative PGUN technology under the SBIR Program and obtained US and International Patents

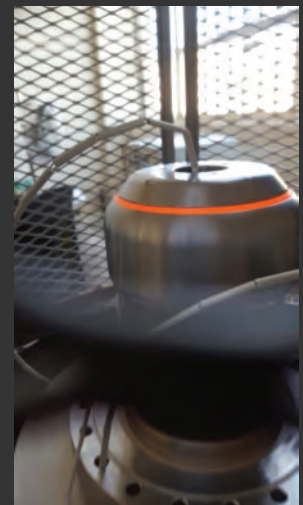
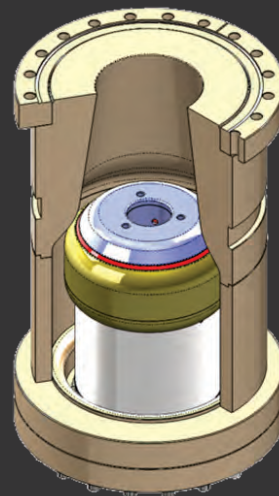



# 2019

## Arizona State University (ASU) Compact X-ray Light Source

- Fabricated three new split-section X-band Accelerator Structures for ASU's Compact X-ray Light Source

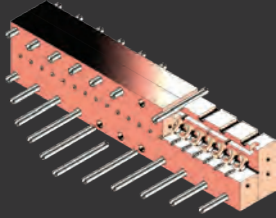

- Manufactured X-band high power RF gun using elastic averaging

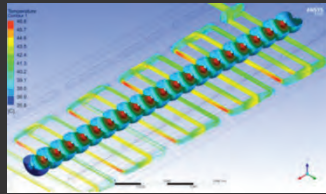

- Fabricated RF components and waveguide systems

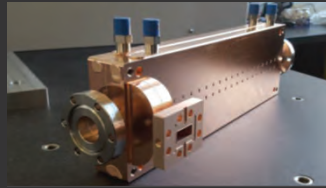

# 2021

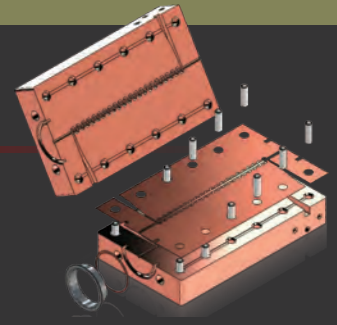
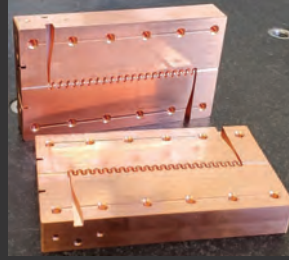

**Ka-band Circuit** - Demonstrated micron level alignment capabilities with elastic averaged Ka-band serpentine circuit for US Navy, patent pending

# 2022

**Ion-Linac** - Interdigital H-Type Structure Deuteron 430 MHz Linac Development



**C-band Structure** - Designed and fabricated high precision C-band Accelerator split-section structure for Los Alamos National Laboratory

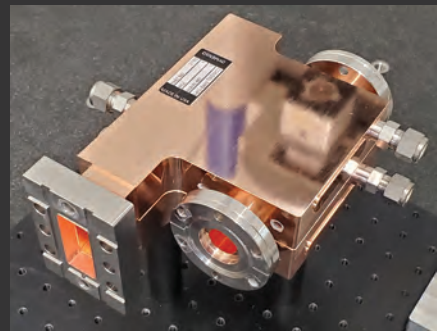

# 2020

**LCLS-II Average Current Monitor (ACM)** - Designed and fabricated 3 ACMs for SLAC's LCLS-II project to help protect against overloading of a 4 GeV Continuous Wave at their new kilometer accelerator tunnel

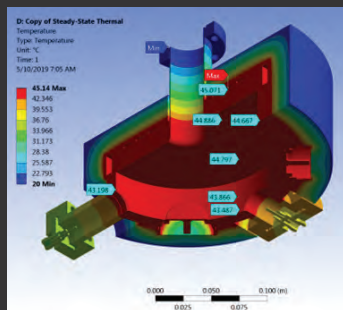
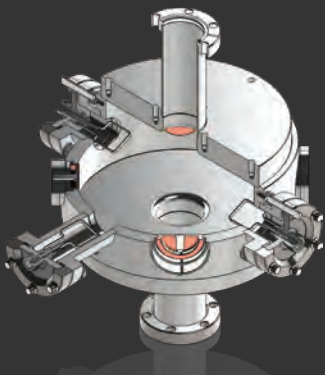

# Capabilities & Scope of Operations

**Dymenso is a premier provider of analysis driven engineering and fabrication solutions for the vacuum electron device industry. Dymenso provides custom engineering and manufacturing of electron beam and microwave devices ranging from the milliwatt to the megawatt level, developing innovative precision engineering products in the following areas:**

- **Microwave Device Design:** Thermal Mechanical analysis and engineering services for gyrotrons, klystrons, traveling-wave tubes and other microwave devices. Extensive design experiences: Electron Beam Collector, Electron Gun, Interaction Cavity, Circuit Loading and Output Window
- **Microwave Components Analysis and Design:** Design of custom microwave components such as Radio Frequency loads, filters, barrier windows and microwave transmission components
- **Thermal Analysis:** Advanced cooling design, single and multi-phase cooling, Computational fluid dynamics (CFD), electronics cooling
- **Structural Simulation:** Finite Element Analysis, Non-linear behavior modeling, plastic deformation, vibration and fatigue
- **Vacuum Electron Device Manufacturing, Precision Fabrication**

## Current and Past clients include

- US ITER/Oak Ridge National Laboratory
- Naval Research Laboratory
- Communications and Power Industries
- SLAC National Accelerator Laboratory
- Lincoln Laboratory - MIT
- Los Alamos National Laboratory
- Livermore National Laboratory
- Teraphysics
- Zap Surgical
- Accuray
- Leidos